



Thermo65 / Thermo46 Entrance Doors

NEW: Thermo65 Style 820

HÖRMANN



CONTENT

| | |
|----|------------------------------|
| 6 | Good reasons to try Hörmann |
| 10 | Programme overview |
| 12 | Thermo65 |
| 22 | Thermo46 |
| 30 | Safety equipment |
| 32 | Automatic locks, glazings |
| 34 | Handles, embellishments |
| 36 | Colours and surface finishes |
| 40 | Dimensions and fitting data |
| 42 | Hörmann product range |

The colours and surface finishes shown are subject to the limitations of the printing process and cannot be regarded as binding.

Some of the products and equipment details described and illustrated in this catalogue are not standard, but available for a surcharge depending on the equipment option. Please contact your Hörmann Partner with reference to the current price list for specific door equipment.

Descriptions and pictures, information about the scope of delivery, equipment and colour correspond to the time of printing.
Subject to changes and errors.

All rights reserved. No part may be reproduced without our prior permission.



There's no place like home

What's better than coming home after a long day at work and enjoying family life? You can eat, play board games and watch TV together. To be able to enjoy time with your loved ones, you have to feel safe and at ease in your own four walls.

Hörmann Thermo65 and Thermo46 entrance doors will help you with that. Our high-quality construction components feature excellent thermal insulation values, reliable security equipment, a large selection of styles and an attractive price-performance ratio. You are sure to find a Hörmann door that meets your demands on the following pages.





“A good reputation must be earned.”

August Hörmann

In keeping with the tradition started by the company's founder, the name Hörmann delivers brand name quality with extensive product expertise. The family business has over 80 years of experience as a construction component specialist and sees itself as your partner from the very beginning of building and renovation projects. It's no surprise that Hörmann is one of Europe's most successful entrance door providers. All this makes Hörmann entrance doors a reassuring purchase.



1 Quality products from Germany

The entrance door construction is developed and manufactured by Hörmann. Our highly qualified employees work intensively on new products, continual further developments and improvements to details. The results are patents and unique products on the market. Endurance tests under real conditions ensure **mature series products with Hörmann quality.**

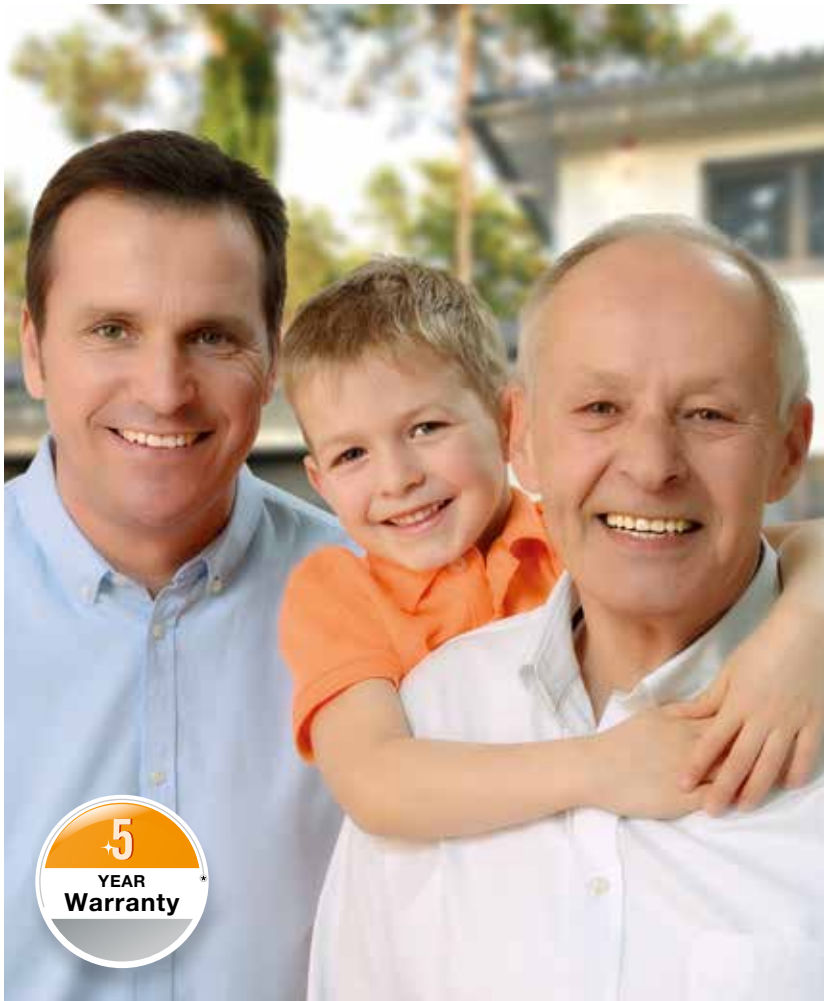

2 Entrance doors for generations

We are convinced of our products and our uncompromising quality assurance. This is why Hörmann issues a **5-year guarantee*** on all **Thermo65 / Thermo46 entrance doors**.

3 An eye on the future

Hörmann is setting a good example. This is why the company obtains **100 % of its required energy from green sources**. At the same time, many tonnes of CO₂ are saved each year thanks to the introduction of an intelligent and certified energy management system. And last but not least, Hörmann offers products for sustainable construction.

* The complete warranty conditions can be found at:
www.hoermann.com



4 Door leaf without visible leaf profile

Door leaf without visible leaf profile

Thermo65 and Thermo46 doors make for an exquisite and elegant reception – whether you use them for a main or a side entrance. **The shapely door leaf with its solid interior and exterior and the leaf profile on the inside fulfils the highest design requirements.** The interior view (shown on page 30) harmonises perfectly with your residential internal doors.

5 High thermal insulation

High thermal insulation

With U_D -values up to approx. $1.1 \text{ W}/(\text{m}^2 \cdot \text{K})^*$, Thermo46 entrance doors provide excellent thermal insulation for your home. **Thermo65 entrance doors feature a U_D -value of up to approx. $0.87 \text{ W}/(\text{m}^2 \cdot \text{K})^*$ for even better thermal insulation.** As a result, you save energy in the long term while also protecting the environment.



Doors of other manufacturers have a disturbed exterior **1** and interior **2** appearance owing to a visible leaf profile.



6 Break-in-resistant locking

For you and your family, being able to rest easy in your own home is important. This is why our **Thermo65 / Thermo46 doors are equipped with multiple-point locking as standard.**

For even more security, many Thermo46 door styles as well as many Thermo65 entrance doors (including with side elements and transom lights) are **optionally available with break-in-resistant RC 2 security equipment.**

7 Safe glazing

When it comes to industrial safety and burglar protection, Hörmann entrance doors fulfil the highest demands. The 8-mm-thick laminated safety glass on the exterior of the insulated glazing provides maximum security. **In case of breakage**, the glass splinters are bound and stay adhered to the plastic film on the inside, **virtually eliminating any danger of being injured by the shards.** Furthermore, the laminated safety glass offers better protection against burglars as it makes reaching through more difficult.

Steel / aluminium entrance door Thermo65

Thanks to the solid door view from the inside, the high-quality Thermo65 doors perfectly match the timber internal doors of your home. You can enjoy the same door view of doors made of different materials for many years to come.

Construction

- Solid, 65-mm-thick steel door leaf with leaf profile on the inside and thick rebate for an elegant door appearance
- Leaf profile made of composite material with thermal break for high stability and thermal insulation
- 80-mm aluminium frame with thermal break and 20-mm-high aluminium/plastic threshold rail with thermal break ensures excellent thermal insulation
- Triple sealing offers optimal protection from rain, wind and dirt
- Triple-pane insulated glazing with safety glass on both sides virtually eliminates all risk of injury in the event of breakage
- Optional RC 2 security equipment for extra security**

Fulfills all requirements of the energy saving regulation

Suitable for fitting without thermal bridges

U_D-value up to approx. 0.87 W/(m²·K)*

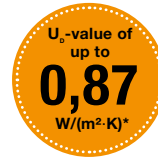

Optional



65 mm



* Approved by IFT
Rosenheim Door size
RAM 1230 × 2180 mm

**Not THP 600S, 820S

Steel / aluminium entrance door Thermo46

All Thermo46 doors are delivered with a solid door leaf to give your entrance doors and residential internal doors a uniform view from the inside.

Construction

- Solid, 46-mm-thick steel door leaf with leaf profile on the inside and thick rebate for an elegant door appearance
- Leaf profile made of composite material with thermal break for good stability and thermal insulation
- 60-mm aluminium frame with thermal break and 20-mm-high aluminium / plastic threshold rail with thermal break ensures good thermal insulation
- Double sealing offers good protection from rain, wind and dirt
- Double-pane insulated glazing with safety glass on both sides virtually eliminates all risk of injury in the event of breakage
- Optional RC 2 security equipment for extra security**

Fulfils all requirements of the energy saving regulation

Suitable for fitting without thermal bridges

U_D -value up to approx. $1.1 \text{ W}/(\text{m}^2\cdot\text{K})^*$

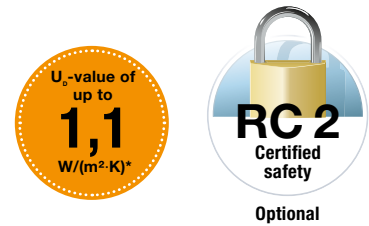

* Approved by IFT
Rosenheim Door size RAM
1230 x 2180 mm

**Not for TPS 020G, 025G,
030G, 040H, 200I, 400I





The entrance door that makes you feel welcome

If you would like to equip your main entrance with an attractive, high-quality door, Hörmann's Thermo65 entrance door is the right choice for you. The solid 65-mm-thick steel door leaf with PU rigid foam infill and the leaf profile on the inside made of composite material keep the cold out. With a U_D -value of up to approx. $0.87 \text{ W}/(\text{m}^2 \cdot \text{K})$, Thermo65 doors feature excellent thermal insulation. As standard, the doors are equipped with a 5-point security lock, allowing you to feel safe and secure in your home. Thermo65 styles are optionally available with RC 2 security equipment to make you feel even more secure in your own four walls.

Choose your ideal entrance door from 15 attractive styles and customise it with one of our 16 preferred colours and 5 Decograin decors.

Distinctive design that reflects
your personal style



Style 010

Decograin Golden Oak, stainless steel handle HB 14-2, Satinato glazing

**Style 015**

Decograin Titan Metallic CH 703 with embellishments in stainless steel look, stainless steel handle HB 14-2

**Style 015**

Standard colour Traffic white RAL 9016, stainless steel handle HB 14-2

**Style 515**

Standard colour Traffic white RAL 9016, silk matt, stainless steel handle HB 14-2

**Style 010**

Preferred colour Grey aluminium RAL 9007, stainless steel embellishment view 751, stainless steel handle HB 14-2

**Style 600S**

Decograin Winchester Oak, stainless steel handle HB 38-2, with surface-mounted Satinato glazing



▲ Thermo65 style 515 in Decograin Titan Metallic CH 703, with side elements

▼ Thermo65 style 900D in Decograin Titan Metallic CH 703



► Thermo65 style 820S in Window grey RAL 7040

Visible design



Style 700B

Preferred colour Decograin Titan Metallic CH 703,
stainless steel handle HB 38-2, sand-blasted glazing with clear stripes

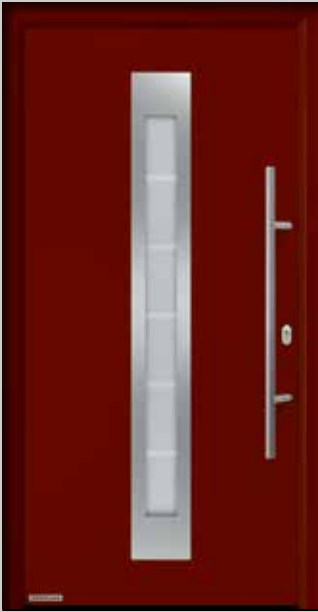
**Style 750C**

Preferred colour Purple red RAL 3004, stainless steel handle HB 38-2, sand-blasted glazing with clear stripes

**Style 800S**

Preferred colour Window grey RAL 7040, stainless steel handle HB 38-2, Satinato glazing

**Style 810E**

Standard colour Traffic white RAL 9016, silk matt, stainless steel handle HB 38-2, sand-blasted glazing with clear stripes

**Style 850B**

Standard colour Traffic white RAL 9016, silk matt, stainless steel handle HB 38-2, sand-blasted glazing with clear stripes

**Style 900D**

Standard colour Traffic white RAL 9016, silk matt, stainless steel handle HB 38-2, sand-blasted glazing with clear stripes

**Style 820S ■ NEW**

Decograin Dark Oak, stainless steel handle HB 38-2, Satinato glazing





Style 100

Standard colour Traffic white RAL 9016, stainless steel handle HB 14-2



Style 430E

Standard colour Traffic white RAL 9016, stainless steel handle HB 14-2, sand-blasted glazing with clear stripes



Style 450E

Standard colour Traffic white RAL 9016, stainless steel handle HB 14-2, sand-blasted glazing with clear stripes



Style 410S

Standard colour Traffic white RAL 9016 stainless steel handle HB 14-2, Satinato glazing



Turn your entrance into an eye-catcher

The Thermo46 doors offer you everything that makes for an excellent entrance door. With a U_D -value up to approx. $1.1 \text{ W}/(\text{m}^2 \cdot \text{K})$, the Thermo46 doors achieve excellent thermal insulation values. Thanks to the standard 5-point security lock, the entrance doors are well equipped when it comes to security. Some styles are optionally available with RC 2 security equipment to make you feel even more secure in your own four walls.

Choose your favourite from 13 door styles – from modern to classic. You can customise your Hörmann door with colours, glazings, side elements and transom lights according to your preferences.



For everyone who values elegance



Style 750C

Standard colour Traffic white RAL 9016, silk matt,
stainless steel handle HB 38-2, sand-blasted glazing with clear stripes

**Style 700B**

Decograin Titan Metallic CH 703,
stainless steel handle HB 38-2,
sand-blasted glazing with clear stripes

**Style 900D**

Decograin Golden Oak,
stainless steel handle
HB 38-2, sand-blasted
glazing with clear stripes

**Style 515**

Decograin Titan Metallic
CH 703 with embellishments
in stainless steel look,
stainless steel handle
HB 14-2

**Style 015**

Standard colour Traffic
white RAL 9016, silk matt,
stainless steel handle
HB 14-2, optionally with
embellishments in stainless
steel look

**Style 025G**

Standard colour Traffic white
RAL 9016, silk matt, with
embellishments in stainless
steel look, stainless steel
handle HB 14-2,
Mastercarré glazing



**Style 010**

Preferred colour Anthracite grey RAL 7016, stainless steel handle HB 14-2, optionally with stainless steel embellishments (see page 35)

**Style 020G**

Standard colour Traffic white RAL 9016, silk matt, stainless steel handle HB 14-2, Mastercarré glazing

**Style 030G**

Preferred colour Window grey RAL 7040, stainless steel handle HB 14-2, Mastercarré glazing

**Style 040H**

Standard colour Traffic white RAL 9016, silk matt, stainless steel handle HB 14-2, round glazing Ø 300 mm, ornamental glass 504





Style 100

Standard colour Traffic white RAL 9016, silk matt, stainless steel handle HB 14-2



Style 200I

Standard colour Traffic white RAL 9016, silk matt, stainless steel handle HB 14-2, Cathedral glass



Style 400I

Standard colour Traffic white RAL 9016, silk matt, stainless steel handle HB 14-2, Cathedral glass

Reassuring security

5-point security lock

You will feel safe at home: 2 conical swing bolts **4** engage with 2 additional security bolts **3** and 1 lock bolt **2** in the frame's lock plates and pull the door tightly shut. The lock plates on Thermo65 doors are adjustable for an optimal door setting. Thanks to the soft-lock latch **1**, the door closes very quietly.



Securing the hinge side

Being able to rest easy in your own home is important, which is why your Thermo46/Thermo65 door is secured additionally on the hinge side, making it practically impossible to force the door open.

5 Thermo46

With 3 security bolts

6 Thermo65

With continuous security strip made of aluminium

7 Perfectly hung with 3-way adjustable guide rollers

Sturdy, two-part 3-way adjustable hinges with safety pins and stainless steel decorative covers guarantee smooth door function.

8 Interior lever

Each door comes with a beautifully shaped stainless steel interior lever as standard.

9 Exterior rose escutcheon

Thermo65 and Thermo46 doors come with a stainless steel exterior rose escutcheon as standard. The security sliding rose escutcheon for Thermo65 doors makes it more difficult to manipulate the locking cylinder, making it ideally equipped in terms of security.

10 Profile cylinder

Delivered with 5 keys as standard. With emergency and hazard function, i.e. the door lock can still be operated when the key is inserted on the inside.

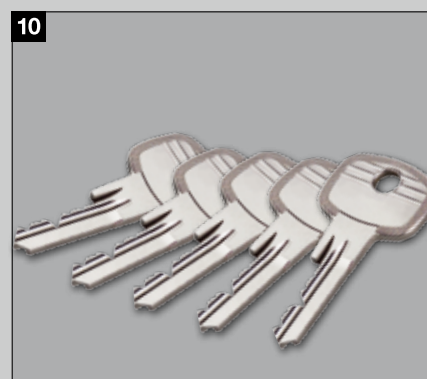

Custom equipment

Automatic lock with mechanical self-locking

When the door falls shut, the bolts automatically extend and securely lock the entrance door.

Automatic lock with electric motor

Open your entrance door easily and conveniently via multiple-point locking using a hand transmitter or radio finger-scan. There's no longer any danger of forgetting your keys. Your entrance door automatically unlocks via an electric motor. You can then push the door open.

- 1** Hand transmitter HSE 4 BS black textured surface with black plastic caps
- 2** Radio finger-scan FFL 12 BS

Electric strike (not shown)

With the electric strike catch, you can conveniently open your door via a switch inside the house. Alternatively, e.g. during the day, you can also toggle the locking lever so that the entrance door can be opened by a slight push from the outside.

Door drip (not shown)

Attractive protection: The door drip in Traffic white RAL 9016 or in a stainless steel look diverts driving rain and is easy to retrofit.

Retractable bottom seal (not shown)

■ **NEW** This optional equipment is the best solution for sealing Thermo65 entrance doors without threshold rail used for barrier-free entrances.

Frame variants



The 80 mm aluminium frame with thermal break and PU foam infill is available in either a round-style **3** or rectangular profile **4**, without surcharge.



Glazings for doors



Thermo65
With triple-pane glazing
Style 700 / 750 / 800 /
810 / 820 / 850 / 900

Thermo46
With triple-pane glazing
Style 700 / 750 / 900

These styles offer a nearly solid look on the inside and outside. The stainless steel glazing frame complements the elegant overall appearance. Insulated glazing is convincing when it comes to saving energy thanks to high thermal insulation values.



Thermo46
With double-pane glazing
Style 020 / 025 / 030 / 040

These doors are equipped with insulated glazing, guaranteeing excellent thermal insulation. A modern, harmonious overall door appearance is created with a round-style plastic glazing frame. With Decograin surfaces, the glazing frame is painted in a colour complementing the surface finish.



Thermo65
With triple-pane glazing
Style 410 / 430 / 450

Thermo46
with double-pane glazing
Styles 200/400

Panelled door styles are a stylish way to present your home with their perfectly matching profile-style plastic glazing frames. When it comes to thermal insulation, insulated glazing gives you everything you could want from a high-quality Hörmann entrance door.



Thermo65
With triple-pane glazing
Style 600

The black contrast frame gives the surface-mounted glazing an elegant appearance. Insulated glazing also ensures high thermal insulation, as you would expect in a modern entrance door.

Glazings for side elements and transom lights

Thermo46 doors are supplied with side elements and transom lights with double-pane insulated glazing, Thermo65 doors with triple-pane insulated glazing.



Satinato
(Thermo65)



Sand-blasted /
sand-blasted with
clear stripes
(Thermo65, Thermo46)

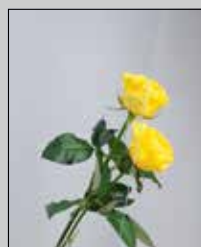

Clear glass
(Thermo65, Thermo46)

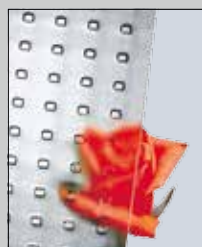

Mastercarré
(Thermo46)

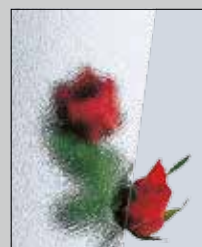

Ornament 504
(Thermo46)



Cathedral small
hammered finish
(Thermo46)

A beautiful handle accents the door:
 select your desired handle

As standard, all doors come with the exterior handles shown in the product photos (from page 14). Alternatively, you can select a different handle made of stainless steel.

Exterior handles

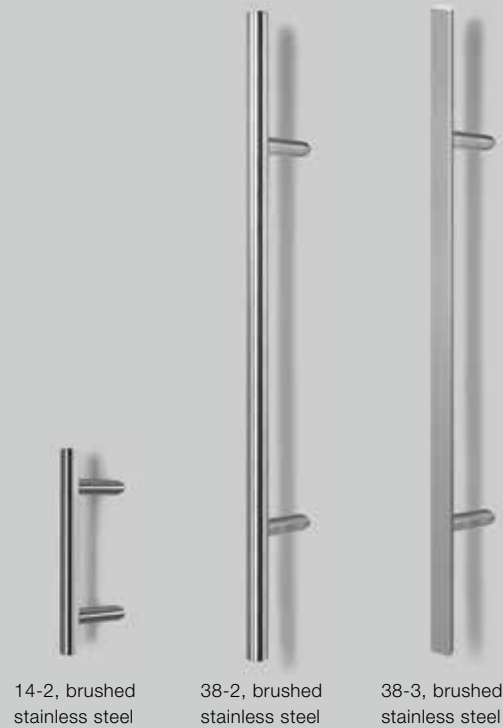

Lever handle sets for outside and inside

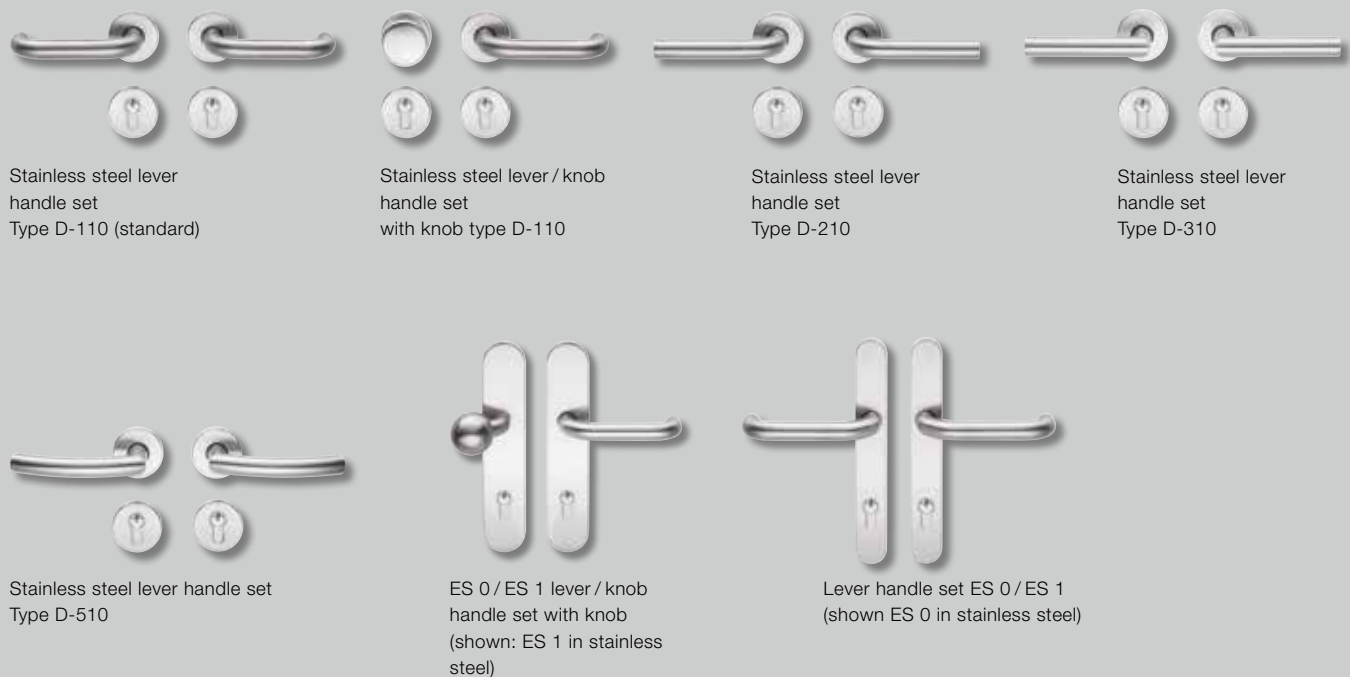

Stainless steel embellishments beautify your entrance

Design the exterior of style 010 using these attractive stainless steel embellishments. The embellishments are available for Thermo65 and Thermo46 door versions and for all door colours or decors.



Style 010, view 451



Style 010, view 454



Style 010, view 457



Style 010, view 459



Style 010, view 750



Style 010, view 751

Find your favourite colour

Do you prefer a subtle Window grey or would you like to show your true colours with Ruby red? When choosing a colour for your new Hörmann entrance door, we let your creativity run wild. You can choose between the particularly inexpensive Traffic white RAL 9016 and 16 additional preferred colours*. The interior and exterior of your Thermo65 or Thermo46 doors are always the same colour. Simply contact your Hörmann partner.

In low-cost Traffic white as standard



16 preferred colours*

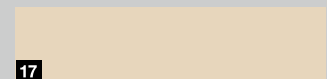
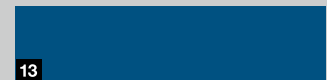
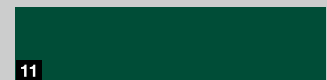
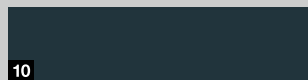
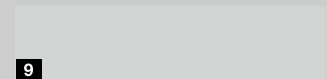
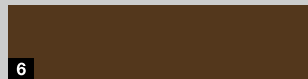
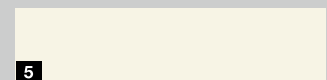
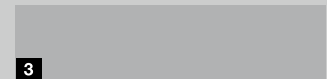

- 1 RAL 9016 Traffic white
- 2 RAL 9007 Grey aluminium
- 3 RAL 9006 White aluminium
- 4 RAL 9002 Grey white
- 5 RAL 9001 Cream
- 6 RAL 8028 Terra brown
- 7 RAL 8003 Clay brown
- 8 RAL 7040 Window grey
- 9 RAL 7035 Light grey
- 10 RAL 7016 Anthracite grey
- 11 RAL 6005 Moss green
- 12 RAL 5014 Pigeon blue
- 13 RAL 5010 Gentian blue
- 14 RAL 3004 Purple red
- 15 RAL 3003 Ruby red
- 16 RAL 3000 Flame red
- 17 RAL 1015 Light ivory

Elegance and detailed accuracy

Decograin** is available in four natural-looking timber designs and one anthracite design with a metallic effect. An embossed wood grain gives it an authentic timber character.

5 Decograin decors**

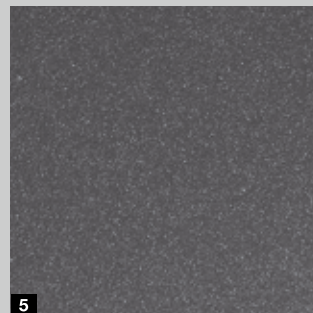
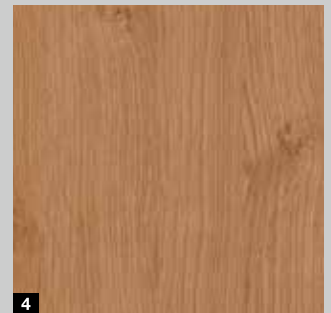
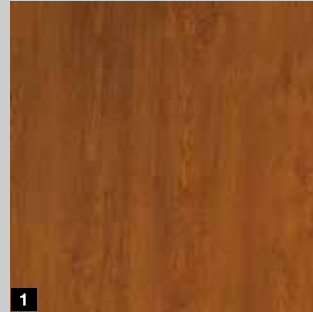

- 1 Golden Oak: medium brown, golden yellow oak design
- 2 Dark Oak: walnut-coloured oak decor
- 3 Night Oak: dark, intense oak design
- 4 Winchester Oak: natural-coloured knotty oak design
- 5 Titan Metallic CH 703: anthracite with a metallic effect

Please note:

The colours and surface finishes shown are subject to the limitations of the printing process and cannot be regarded as binding. Dark colours should not be used for doors that are exposed to the sun, as an increased material expansion may impair the door's function.

* Not available for Thermo65 styles 410, 430, 450.

**Not available for Thermo65 styles 100, 410, 430, 450 and Thermo46 styles 100, 200, 400. Glazing frames in matching colours for Thermo46 styles 020, 025, 030, 040.

Door leaf and frame in different colours

Customise your entrance area

For Thermo65 and Thermo46 entrance doors, you can order the door leaf and frame in different colours to fit your own individual taste. Combine the standard colour Traffic white RAL 9016, 16 preferred colours or 5 Decograin decors to perfectly match your home and decorating style.



Frame in White aluminium RAL 9006,
door leaf in Grey aluminium RAL 9007



Frame in Titan Metallic CH 703,
door leaf in Traffic white RAL 9016



Frame in White aluminium RAL 9006,
door leaf in Titan Metallic CH 703



Frame in Anthracite grey RAL 7016,
door leaf in Purple red RAL 3004

Entrance doors in harmony with internal doors

Design your Thermo65 entrance door in Decograin Golden Oak, Dark Oak or Titan Metallic CH 703 on the inside to match your white internal doors. All door styles are available with rounded frames, as well as the side elements, in the Decograin decors listed, on the inside in Traffic white RAL 9016 – on request with side elements in the same colour combination. This way, you can enjoy your perfectly matching entrance door and internal doors.

Two-colour entrance doors and side elements



Viewed from outside in Decograin surface



Viewed from inside in Traffic white RAL 9016*

Please note:

The colours and surface finishes shown are subject to the limitations of the printing process and cannot be regarded as binding. Dark colours should not be used for doors that are exposed to the sun, as an increased material expansion may impair the door's function.

* Not available for Thermo65 styles 100, 410, 430, 450 and all Thermo46 styles.

SIZES AND FITTING DATA

Standard sizes
Thermo65

| Overall frame dimension (ordering size) | Structural opening | Clear frame dimension |
|---|--------------------|-----------------------|
| 1000 x 2100 | 1020 x 2110 | 850 x 2005 |
| 1100 x 2100 | 1120 x 2110 | 950 x 2005 |

Standard sizes
Thermo46

| Overall frame dimension (ordering size) | Structural opening | Clear frame dimension |
|---|--------------------|-----------------------|
| 1000 x 2100 | 1020 x 2110 | 872 x 2016 |
| 1100 x 2100 | 1120 x 2110 | 972 x 2016 |

Special sizes
Thermo65 / Thermo46

| Styles | Overall frame dimension (ordering size) |
|---|---|
| 200 | 875 – 1100 x 1990 – 2186 |
| 010, 020, 030, 040, 700, 750, 800, 810, 900 | 700 – 1250 x 1875 – 2250 |
| 015, 025, 515 | 875 – 1250 x 1875 – 2250 |
| 100, 400, 410, 430, 450 | 875 – 1100 x 1875 – 2186 |
| 820, 850, 900 | 800 – 1250 x 1875 – 2250 |

Thermo65

Frame variants

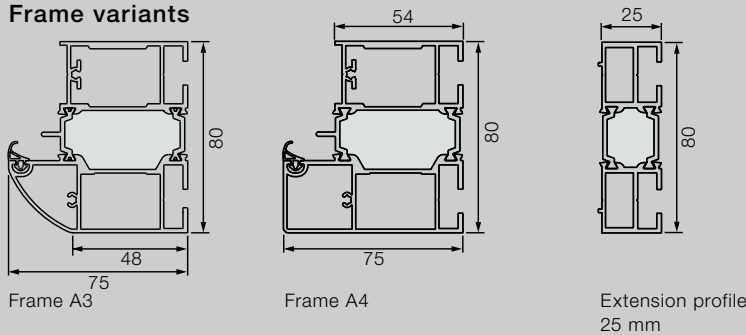

Horizontal view of door

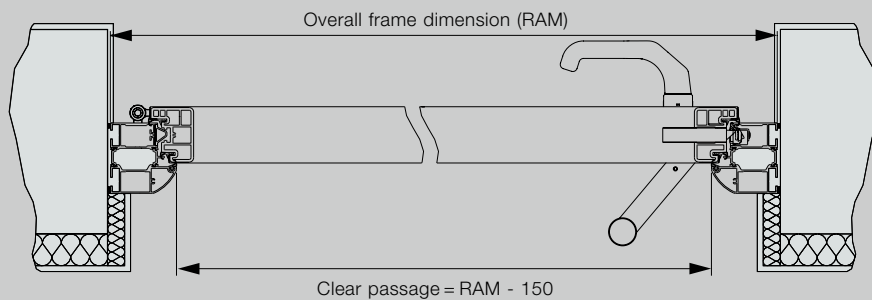

Vertical view of door

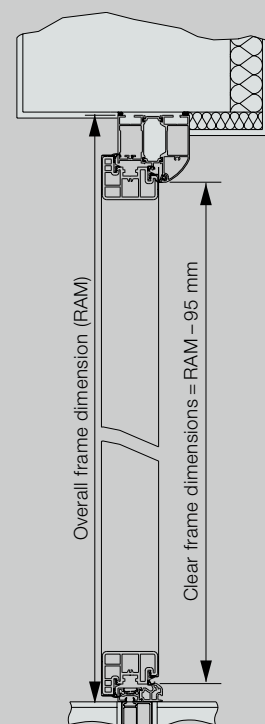

Horizontal view of side element

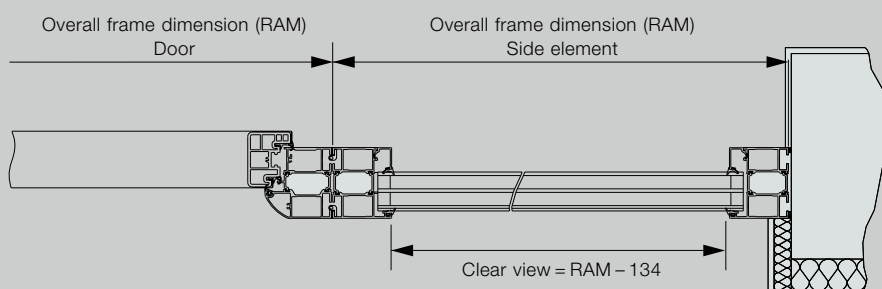

All dimensions in mm

Side element standard sizes
Thermo65 / Thermo46

| Version | Overall frame dimension (ordering size) |
|----------------|---|
| Thermo 65 / 46 | 400 x 2100 |

Side element special sizes
Thermo65 / Thermo46

| Versions | Overall frame dimension (ordering size) |
|----------|---|
| Thermo46 | 300 – 1000* x 1875 – 2250 |
| Thermo65 | 300 – 1000* x 1875 – 2250 |

* Transom light not possible from a width of 500 mm. Door sets with side elements do not contribute to the static equilibrium, which must be guaranteed by the building structure.

Transom light special sizes
Thermo65 / Thermo46

| Version | Overall frame dimension (ordering size) |
|----------------|---|
| Thermo 65 / 46 | 875 – 2250 x 300 – 500 |

Thermo46

Frame variants

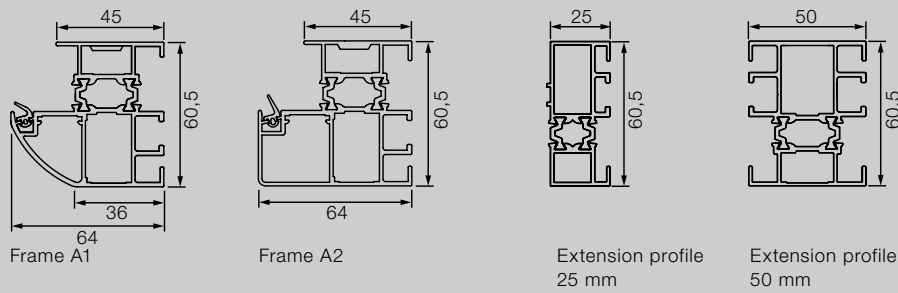

Horizontal view of door

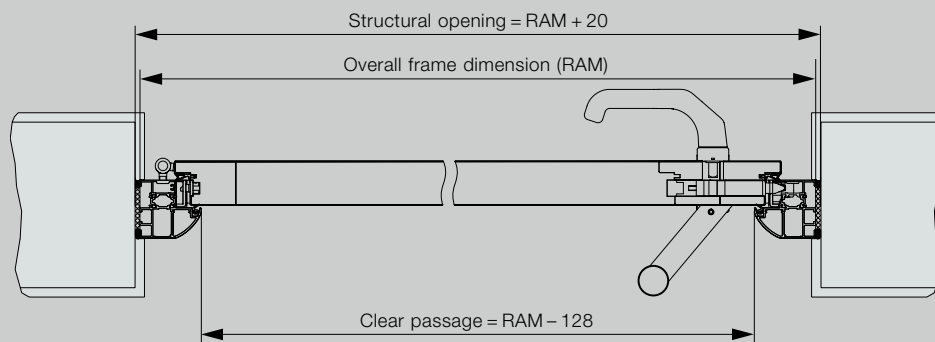

Vertical view of door

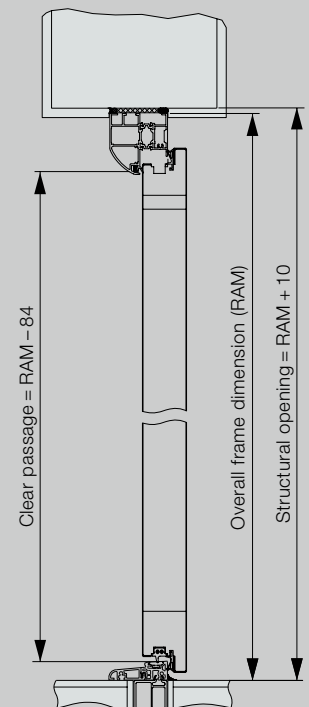

Horizontal view of side element

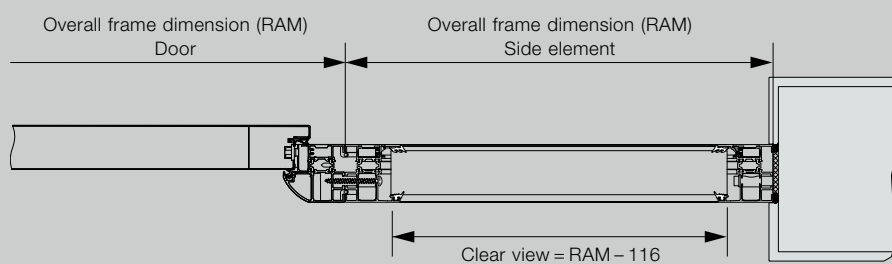

All dimensions in mm



Experience Hörmann quality in new construction and modernisation

Hörmann provides an excellent basis for comprehensive planning. Carefully matched solutions offer you the very best in perfectly designed products for every area.

- **Garage doors**

Optimally match your personal architectural style: up-and-over or sectional doors made of steel or timber.

- **Gate and Door Operators**

Enjoy extra convenience and break-in-resistant security with Hörmann operators for garage doors and entrance gates. You can profit from the convenience of Hörmann door operators in your residential space as well.

- **Entrance doors**

Our comprehensive entrance door ranges include models that fit almost every need and requirement.

- **Steel doors**

Sturdy doors for your entire home, from basement to roof.

- **Frames**

Choose from our comprehensive range of products for new construction, expansion and modernisation.



Garage doors and entrance gate operators



Thermo65 / Thermo46 entrance doors



Steel doors

Hörmann: Quality without Compromise



Hörmann KG Amshausen, Germany



Hörmann KG Antriebstechnik, Germany



Hörmann KG Brandis, Germany



Hörmann KG Brockhagen, Germany



Hörmann KG Dissen, Germany



Hörmann KG Eckelhausen, Germany



Hörmann KG Freisen, Germany



Hörmann KG Ichttershausen, Germany



Hörmann KG Werne, Germany



Hörmann Alkmaar B.V., Netherlands



Hörmann Legnica Sp. z o.o., Poland



Hörmann Beijing, China



Hörmann Tianjin, China



Hörmann LLC, Montgomery IL, USA



Hörmann Flexon LLC, Burgettstown PA, USA



Shakti Hörmann Pvt. Ltd., India

Hörmann is the only manufacturer worldwide that offers you a complete range of all major building products from one source. We manufacture in highly-specialised factories using the latest production technologies. The close-meshed network of sales and service companies throughout Europe, and activities in the USA and Asia, make Hörmann your strong partner for first-class building products, offering “Quality without Compromise”.

GARAGE DOORS
OPERATORS
INDUSTRIAL DOORS
LOADING EQUIPMENT
HINGED DOORS
DOOR FRAMES