

NEW

**Decograin surface finishes Winchester Oak
and Titan Metallic CH 703,
as well as 5 new preferred colours**



ThermoPro Entrance Doors

With solid door leaf and high thermal insulation



Enjoy your home

Entrance doors in proven Hörmann quality



Hörmann's steel ThermoPro doors are available in a large selection of styles. Thanks to standard multiple-point locking, these inexpensive doors give you a feeling of security, save energy through excellent thermal insulation and provide a stylish appearance for your home.



Quality products from Germany

All entrance door components are developed and produced in-house at Hörmann. Our highly qualified employees work intensively on new products, continual further developments and improvements to details. Patents and unique products on the market are the result of this. Endurance tests under real conditions ensure mature series products with Hörmann quality.

CE mark in accordance with EN 14351-1

The CE mark confirms compliance with and observance of the principal requirements of the product standard EN 14351-1 for all of our entrance doors.



Entrance doors for generations

We are convinced of our products and our uncompromising quality assurance. That is why we issue a 5-year guarantee* on all Hörmann entrance doors.



An eye on the future

Hörmann is setting a good example. This is why, since 2013, the company has obtained 40 % of its required energy from green sources and will continue to increase this percentage. At the same time, many tonnes of CO₂ are saved each year thanks to the introduction of an intelligent and certified energy management system. And last but not least, Hörmann offers products for sustainable construction. Find out more about Hörmann's environmental activities in the "We think green" brochure.

* The complete warranty conditions can be found at: www.hormann.co.uk

Good reasons to try Hörmann

Innovations from the market leader



1

**Solid door leaf
inside and outside**

ThermoPro entrance doors will convince you with their contemporary design: A beautifully shaped, solid steel door leaf on the interior and exterior with a leaf profile on the inside simply looks good. The solid door view from the inside gives the impression of a residential internal door and blends perfectly with your house's interior.



Doors of other manufacturers have a disturbed appearance owing to a visible leaf profile

2

**High thermal
insulation**

Today, everything depends on saving energy everywhere in the home, and ThermoPro doors also play their part. Thanks to a 46-mm or 65-mm-thick door leaf completely filled with PU rigid foam, these doors provide excellent thermal insulation, reducing your energy bills!

ThermoPro

U_D-value of up to 1.1 W/(m²·K)

ThermoPro Plus

U_D-value of up to 0.82 W/(m²·K)



3

Break-in-resistant locking

Because you and your family want to feel safe at home, all ThermoPro doors are equipped with multiple-point locking as standard for extra security. The hinge side of ThermoPro doors is secured with three security bolts. A continuous safety device strip secures ThermoPro Plus doors against forced opening, giving you a reassuring feeling.

Break-in-resistant RC 2 security equipment

All ThermoPro Plus entrance doors, including those with side elements and transom lights, as well as many ThermoPro entrance door styles, also come with RC 2 equipment for more security for you and your family.



RC 2 describes the door's resistance class against break-ins and corresponds to the former class WK 2.



4

Shatterproof glazing

ThermoPro doors are equipped with a double or triple glazing as standard. Both the inside and outside consist of safety glass, which, for you, means: should the pane ever burst, it will break into little pieces with no sharp edges – considerably reducing the risk of injury for you and your family.

ThermoPro entrance door

The inexpensive version for side entrances

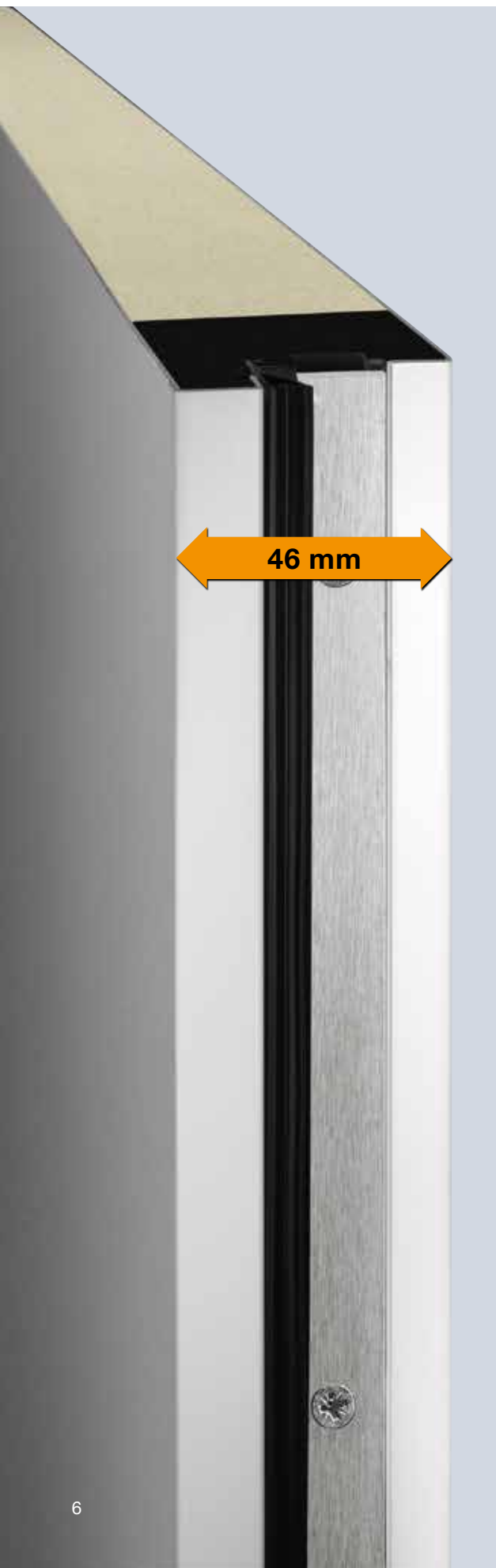

Door leaf

All ThermoPro doors are equipped with a solid, 46-mm-thick interior and exterior steel door leaf with internal leaf profile and thick rebate design. The solid door view from the inside corresponds to a residential internal door and can be optimally integrated into your house's interior.

Leaf profile

The leaf profile made of composite material has a thermal break and is very stable, ensuring that the door leaf never warps.

Thermal insulation

With the PU-foamed door leaf and thanks to a thermal break, ThermoPro doors provide excellent thermal insulation for your home with a U_D -value of up to $1.1 \text{ W}/(\text{m}^2 \cdot \text{K})$.

Break-in resistance

ThermoPro TPS 700/750/900/010/015 and 100 door styles come optionally without side elements and transom lights, with RC 2 equipment. The doors are approved for being fitted opening inwards.



Frame

The **60 mm** aluminium frame with thermal break is available in a round (top figure) or rectangular profile (bottom figure).



Round-style (profile A1)



Rectangular version (profile A2)

Seal

Save valuable energy: a 20-mm-high aluminium/plastic threshold with thermal break and **double sealing** reduces heat loss. The additional brush seals at the bottom provide optimum protection against bad weather.



ThermoPro Plus entrance door

The high-quality version with the best insulation



Door leaf

The high-quality ThermoPro Plus doors are equipped with a solid 65-mm-thick steel door leaf with a leaf profile on the inside and a thick rebate. The solid door view from the inside gives the impression of a residential internal door and blends harmoniously with the look of your house's interior.

Leaf profile

The leaf profile made of composite material components creates a better thermal break, providing higher stability and ensuring that the door leaf never warps.

Thermal insulation

With a U_D -value of up to $0.82 \text{ W}/(\text{m}^2 \cdot \text{K})$, the ThermoPro Plus version is the best when it comes to thermal insulation, saving you energy in the long term.

Break-in resistance

All ThermoPro Plus entrance door styles, as well as side elements and transom lights, come with optional RC 2 security features. The doors are approved for being fitted opening inwards and outwards.



Frame

The **80 mm** aluminium frame with thermal break and PU foam infill is available in a round (top figure) or rectangular profile (bottom figure).

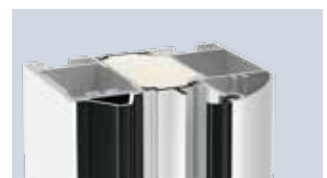

Round-style (profile A3)

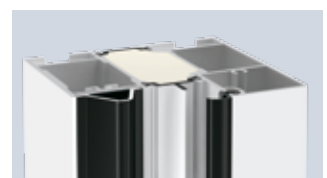

Rectangular version (profile A4)

Seal

ThermoPro Plus doors are characterised by their well thought-out details, such as the 20-mm-high aluminium / plastic threshold **with triple sealing** and thermal break. This improves the door's thermal insulation, saving you energy.



Fully equipped as standard

Brand quality will win you over in every respect

5-point security lock

You will feel safe at home: 2 conical swing bolts engage with 2 additional security bolts and 1 lock bolt in the frame's lock plates and pull the door tightly shut. The lock plates on ThermoPro Plus doors are adjustable for an optimal door setting. With a soft-lock latch to quietly close the door.



1 Soft-lock latch



2 Locking rod



3 Swing bolt with security bolts

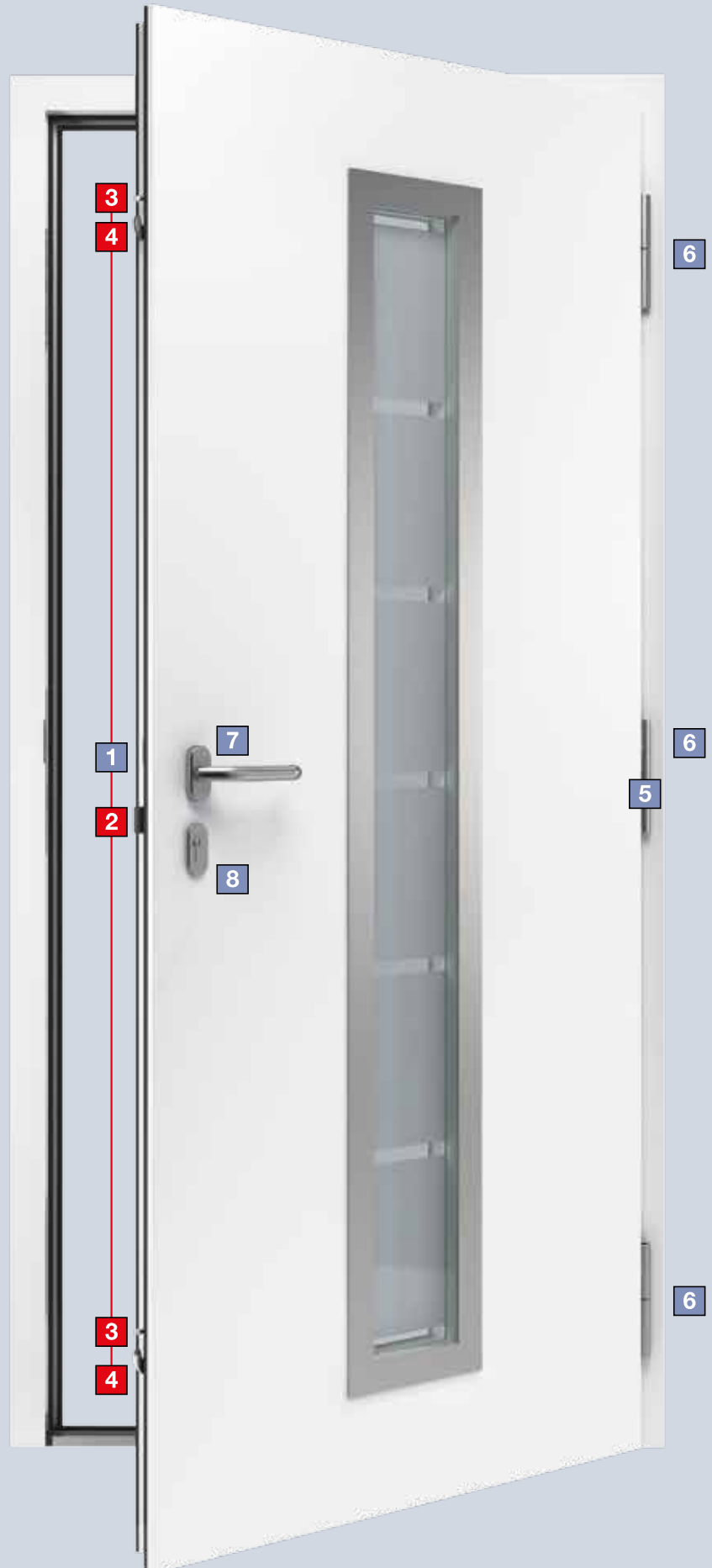



Hörmann ThermoPro doors are free of VOC emissions, tested by the IFT Rosenheim

Securing the hinge side

Being able to rest easy in your own home is important, which is why your ThermoPro / ThermoPro Plus door is secured additionally on the hinge side, making it practically impossible to force the door open.



ThermoPro
With 3 security bolts



ThermoPro Plus
with continuous safety device strip made of aluminium

Lever handles and hinges

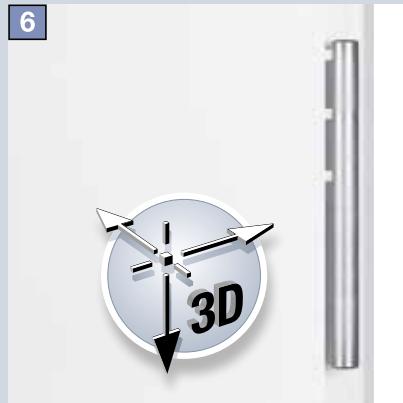

Perfectly hung with 3-way adjustable guide rollers

Sturdy, two-part 3-way adjustable hinges with safety pins and stainless steel decorative covers guarantee smooth door function.



Interior lever

Each door comes with a beautifully shaped stainless steel interior lever and rose escutcheon on the exterior as standard.



Profile cylinder

Delivered with 5 keys as standard. With emergency and hazard function, i.e. the door lock can still be operated when the key is inserted on the inside.

Optional extras for added convenience:

Electric strike

With the electric strike catch, you can conveniently open your door via a switch inside the house. Alternatively, e.g. during the day, you can also toggle the locking lever so that the entrance door can be opened by a slight push from the outside.

Window drip

Attractive protection: The door drip in Traffic white RAL 9016 diverts driving rain and is easy to retrofit.

Exclusive glazing

With triple glazing and high-quality stainless steel glazing frames



All of these door styles are also available in the ThermoPro Plus version with especially high thermal insulation!



Style 700 ThermoPro Plus
In Traffic white RAL 9016



Style 750 ThermoPro Plus
In Traffic white RAL 9016



Style 850 ThermoPro Plus
In Traffic white RAL 9016



Style 900 ThermoPro Plus
In Traffic white RAL 9016

◀ **Style 900** in Titan Metallic,
with side element (optional)

Styles 700 / 750

Stainless steel handle HB 38-2 on steel infill, full glazing: Triple-pane insulated glass, clear laminated safety glass outside, clear float, sandblasted with clear horizontal stripes in the centre, clear single-pane safety glass inside.

Style 700 versions

- ThermoPro (U_D -value up to 1.2 W/(m²·K)^{*})
- ThermoPro Plus (U_D -value up to 0.94 W/(m²·K)^{*})

Style 750 versions

- ThermoPro (U_D -value up to 1.2 W/(m²·K)^{*})
- ThermoPro Plus (U_D -value up to 0.91 W/(m²·K)^{*})

Styles 850/900

Stainless steel handle HB 38-2 on steel infill, with rounded glazing: Triple-pane insulated glass, laminated safety glass outside, float glass sandblasted with clear horizontal stripes in the centre, clear single-pane safety glass inside.

Style 850 version

- ThermoPro Plus (U_D -value up to 0.92 W/(m²·K)^{*})

Style 900 versions

- ThermoPro (U_D -value up to 1.2 W/(m²·K)^{*})
- ThermoPro Plus (U_D -value up to 0.92 W/(m²·K)^{*})

Side elements / transom lights

- Insulated glass, laminated safety glass on the outside and sandblasted single-pane safety glass without clear stripes on the inside.
- Insulated glass, laminated safety glass outside, single-pane safety glass inside.



Glazing frame

Stainless steel

Colours / surface finishes

- In 15 preferred colours
- In 5 Decograin surfaces

RC 2 version

All ThermoPro Plus entrance door styles, including those with side elements and transom lights, as well as ThermoPro 700 / 750 / 900 door styles are optionally available in the break-in-resistant RC 2 version.



^{*} Dependent on door size.
Specified values for RAM 1230 x 2180 mm.

Long-lasting brand quality

Thanks to hot galvanization, corrosion protection and high-quality polyester paint



Matching canopies can be found in the Hörmann aluminium entrance door programme



Style 010 ThermoPro
In Traffic white RAL 9016



Style 020 ThermoPro
In Traffic white RAL 9016



Style 030 ThermoPro
In Traffic white RAL 9016



Style 040 ThermoPro
In Traffic white RAL 9016

Style 010

Stainless steel handle HB 14-2 on steel infill

Versions

- ThermoPro (U_D -value up to 1.1 W/(m²·K)^{*})
- ThermoPro Plus (U_D -value up to 0.82 W/(m²·K)^{*})

Style 010 side elements/transom lights

- Insulated glass, exterior laminated safety glass, interior single-pane safety glass, Mastercarré (only ThermoPro)
- Insulated glass, exterior laminated safety glass, interior single-pane safety glass, ornamental glass 504 (only ThermoPro)
- Insulated glass, exterior laminated safety glass, interior single-pane safety glass, sand-blasted
- Insulated glass, exterior laminated safety glass, interior single-pane safety glass, clear

Style 020 / style 030

Stainless steel handle HB 14-2 on steel infill, full glazing:
Double-pane insulated glass, laminated safety glass outside, single-pane safety glass, Mastercarré inside.

Version

- ThermoPro
Style 020: U_D -value up to 1.4 W/(m²·K)^{*},
Style 030: U_D -value up to 1.2 W/(m²·K)^{*}

Style 020/030 side elements/transom lights

- Insulated glass, clear laminated safety glass outside, single-pane safety glass, Mastercarré inside
- Insulated glass, exterior laminated safety glass, interior single-pane safety glass, clear

Style 040

Stainless steel handle HB 14-2 on steel infill, with round glazing
Ø 300 mm: Double-pane insulated glass, laminated safety glass on the outside, single-pane safety glass, ornamental glass 504 on the inside.

Version

- ThermoPro (U_D -value up to 1.2 W/(m²·K)^{*})

Style 040 side elements/transom lights

- Insulated glass, laminated safety glass outside, single-pane safety glass, ornamental glass 504 inside
- Insulated glass, exterior laminated safety glass, interior single-pane safety glass, clear



Glazing frame

Plastic round-style frame

Colours / surface finishes

- In 15 preferred colours
- In 5 Decograin surfaces

RC 2 version

Door style 010 is available as a ThermoPro Plus door, including side elements and transom lights, or as a ThermoPro door, optionally in a break-in-resistant RC 2 version.



◀ **Style 020** in Traffic white RAL 9016, with side elements (optional) and canopy 605 in Traffic white RAL 9016 from Hörmann's Aluminium entrance door programme.

^{*} Dependent on door size.
Specified values for RAM 1230 × 2180 mm.

Ribbed styles

Timeless elegance thanks to matching Hörmann M-ribbed sectional garage doors





Style 015 ThermoPro Plus
In Traffic white RAL 9016



Style 025 ThermoPro
In Traffic white RAL 9016

Style 015

Stainless steel handle HB 14-2 on steel infill, ribbed

Versions

- ThermoPro (U_D -value up to $1.1 \text{ W}/(\text{m}^2\cdot\text{K})^*$)
- ThermoPro Plus (U_D -value up to $0.82 \text{ W}/(\text{m}^2\cdot\text{K})^*$)

Style 015 side elements/transom lights

- Insulated glass, exterior laminated safety glass, interior single-pane safety glass, Mastercarré (only ThermoPro)
- Insulated glass, exterior laminated safety glass, interior single-pane safety glass, ornamental glass 504 (only ThermoPro)
- Insulated glass, exterior laminated safety glass, interior single-pane safety glass, sand-blasted
- Insulated glass, exterior laminated safety glass, interior single-pane safety glass, clear

Style 025

Stainless steel handle HB 14-2 on steel infill, ribbed, full glazing: Double-pane insulated glass, laminated safety glass outside, single-pane safety glass, Mastercarré inside

Version

- ThermoPro (U_D -value up to $1.4 \text{ W}/(\text{m}^2\cdot\text{K})^*$)

Style 025 side elements / transom lights

- Double-pane insulated glass, clear laminated safety glass outside, single-pane safety glass, Mastercarré inside
- Double-pane insulated glass, laminated safety glass outside, clear single-pane safety glass inside



Glazing frame

Plastic round-style frame

Colours / surface finishes

- In 15 preferred colours
- In 5 Decograin surfaces

RC 2 version

Door style 015 is available as a ThermoPro Plus door, including side elements and transom lights, or as a ThermoPro door, optionally in a break-in-resistant RC 2 version.



◀ **Style 015** in Traffic white RAL 9016, with side element (optional)

* Dependent on door size.
Specified values for RAM 1230 x 2180 mm.

Classic appearance

Panel styles for stylish accents in your home





Style 100 ThermoPro
In Traffic white RAL 9016, with side elements (optional)



Style 200 ThermoPro
In Traffic white RAL 9016



Style 400 ThermoPro
In Traffic white RAL 9016

◀ **Style 400** in Traffic white RAL 9016,
with side element (optional)

Style 100

Stainless steel handle HB 14-2 on steel infill, with 6 panels.

Version

- ThermoPro (U_D -value up to $1.1 \text{ W}/(\text{m}^2 \cdot \text{K})^*$)

Style 200

Stainless steel handle HB 14-2 on steel infill, double-pane insulated glass, laminated safety glass outside, single-pane safety glass inside, cathedral glass with small hammered finish with surface-mounted rails

Version

- ThermoPro (U_D -value up to $1.2 \text{ W}/(\text{m}^2 \cdot \text{K})^*$)

Style 400

Stainless steel handle HB 14-2 on steel infill, double-pane insulated glass, laminated safety glass outside, single-pane safety glass inside, cathedral glass with small hammered finish with surface-mounted rails

Version

- ThermoPro (U_D -value up to $1.4 \text{ W}/(\text{m}^2 \cdot \text{K})^*$)

Side elements with panel infill

- Style 100 / 200: 3 panels
- Style 400: 1 panel and double-pane insulated glass, laminated safety glass outside, single-pane safety glass inside, cathedral glass with small hammered finish with surface-mounted rails

Side elements / transom lights

- Double-pane insulated glass, laminated safety glass outside, single-pane safety glass, cathedral glass with small hammered finish inside
- Double-pane insulated glass, laminated safety glass outside, clear single-pane safety glass inside



Glazing frame

Plastic profile-style frame

Colours / surface finishes

- In 15 preferred colours

RC 2 version

Door style 100 is available as a ThermoPro door, without side elements and transom lights, in a break-in-resistant RC 2 version.



*Dependent on door size.
Specified values for RAM 1230 × 2180 mm.

It's Your Choice

Individual handles and glazings for doors, side elements and transom lights



With safety glass inside and outside as standard

Glazings for doors



Styles 700 / 750 / 850 / 900

These styles offer a solid look on the inside and outside. The stainless-steel glazing frame complements its elegant overall appearance. Convincing when it comes to saving energy: triple-pane thermal insulation glass glazings with a high thermal insulation value.



Styles 020 / 025 / 030 / 040

These doors are equipped with a double-pane insulation glass glazing, guaranteeing excellent thermal insulation. A modern, harmonious overall door appearance is created with a round-style plastic glazing frame. With Decograin surfaces, the glazing frame is painted in a colour complementing the surface finish.



Styles 200 / 400

Both panelled door styles are a stylish way to present your home with their perfectly matching profile-style plastic glazing frames. When it comes to thermal insulation, the double-pane insulating glass glazing gives you everything you expect from a high-quality Hörmann entrance door.

Glazings for side elements and transom lights

ThermoPro doors are supplied with the side element and transom lights with double-pane insulated glass glazing, ThermoPro Plus doors with triple-pane insulated glazing. Please refer to the individual door types for glazing options available.



Sand-blasted (TPS, TPS Plus)



Clear glass (TPS, TPS Plus)

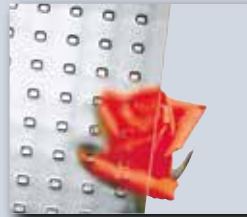

Mastercarré (TPS)



Ornament 504 (TPS)



Cathedral small hammered (TPS)

A beautiful handle and letter slot accents the door: Select your desired handle

As standard, all doors come with the exterior handles shown on pages 10 – 17. For alternative handle designs and options, please consult the price list. The options below are for the Classic door styles only.



Lever handle set (shown in silver)



Lever handle set (shown in gold)



Lever/knob handle set (shown in silver)



Lever/knob handle set (shown in gold)



Security Lever handle set (shown in silver)



Security Lever handle set (shown in gold)



Security Lever/knob handle set (shown in silver)



Security Lever/knob handle set (shown in gold)

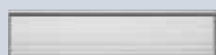

Letter plate (shown in silver)

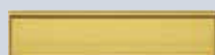

Letter plate (shown in gold)



Spy Viewer
For doors without windows (Optional extra)

A question of taste

Choose your favourite surface finish or colour

Decograin surface finishes

Decograin* is available in four natural-looking timber designs and anthracite with a metallic effect. An embossed wood grain gives it all the aesthetics of timber.



Decograin Golden Oak: medium brown, golden yellow oak design



Decograin Dark Oak: walnut-coloured oak design



Decograin Night Oak: dark, intense oak design



Decograin Winchester Oak: natural-coloured knotty oak design
// NEW from Autumn 2014

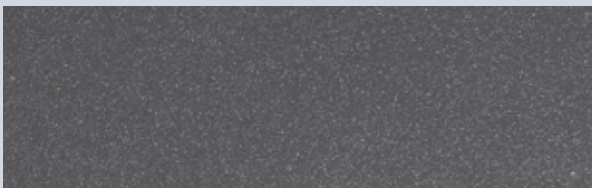

Titan Metallic CH 703: Anthracite with a metallic effect
// NEW from Autumn 2014

In competitively-priced Traffic white as standard

ThermoPro doors are supplied in Traffic white RAL 9016 as standard.

15 preferred colours

Entrance doors also come in 15 inexpensive preferred colours for the exterior and interior.



Grey aluminium RAL 9007 **// NEW**



Anthracite grey, RAL 7016



White aluminium, RAL 9006



Moss green, RAL 6005

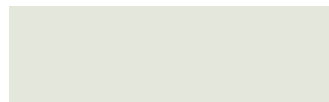

Grey white RAL 9002 **// NEW**



Pigeon blue, RAL 5014

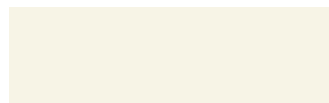

Cream RAL 9001 **// NEW**



Gentian blue RAL 5010 **// NEW**



Terra brown, RAL 8028



Ruby red, RAL 3003



Clay brown, RAL 8003



Flame red RAL 3000 **// NEW**



Window grey, RAL 7040



Light ivory, RAL 1015



Light grey, RAL 7035

The colours and surface finishes shown are subject to the limitations of the printing process and cannot be regarded as binding. Dark colours should not be used for doors that are exposed to the sun, as an increased material expansion may impair the door's function.
* Not available for styles 100/200/400. Colours matched for glazing frame styles 020/025/030/040.

ThermoPro / ThermoPro Plus

Dimensions and fitting data

Sizes

ThermoPro doors

Standard European Sizes	
Overall frame dimension (ordering size)	Clear passage*
1,000 × 2,100	872 × 2,016
1,100 × 2,100	972 × 2,016

ThermoPro Plus doors

Standard sizes	
Overall frame dimension (ordering size)	Clear passage*
1,000 × 2,100	850 × 2,005
1,100 × 2,100	950 × 2,005

ThermoPro/ThermoPro Plus doors

Special sizes	
Styles	Overall frame dimension (ordering size)
100, 200, 400	875 – 1,100 × 1,990 – 2,186
020, 025, 030, 700, 750, 850, 900	875 – 1,250 × 1,990 – 2,250
010, 015, 040	875 – 1,250 × 1,875 – 2,250
ThermoPro Plus 700, 750, 850, 900	875 – 1,250 × 1,875 – 2,250

ThermoPro

Frame variants

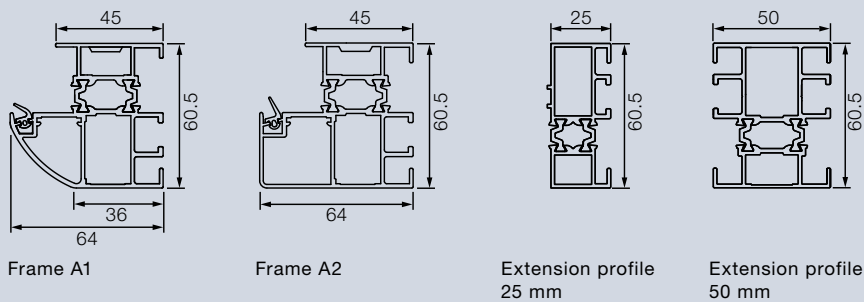

* The clear passage width does not allow for the handle projection on the width.

** The structural opening height is based on the finished floor dimension which includes any and all floor coverings. (Please note that each application/project is unique and the tolerance may alter) These doors are rebated on all four sides, failure to take the floor covering into consideration could prevent the door from opening.

Horizontal view of door

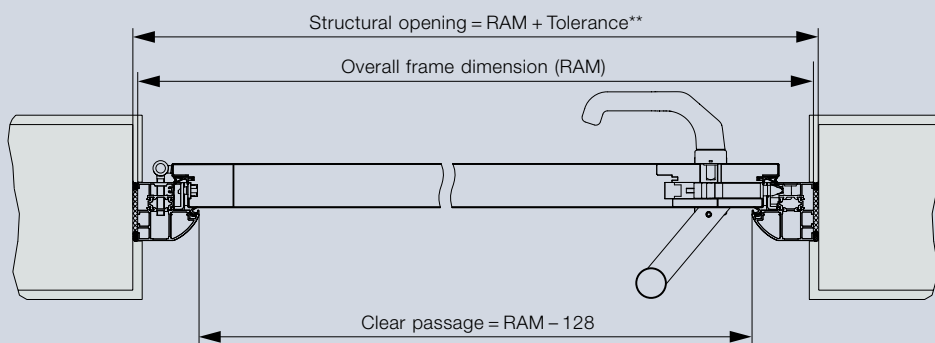

Vertical view of door

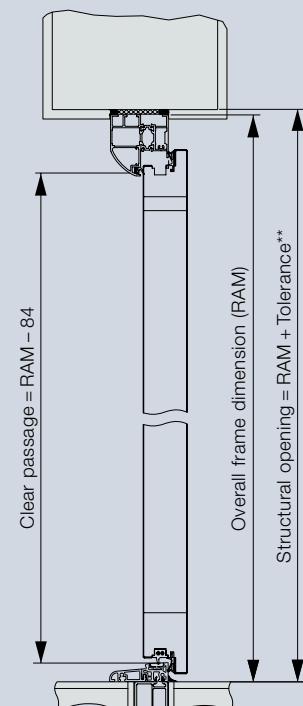

Horizontal view of side element

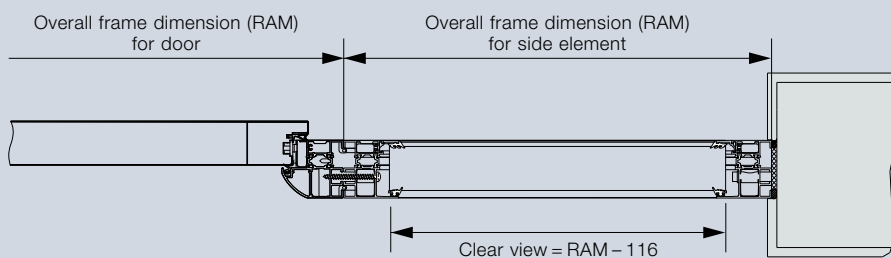

ThermoPro / ThermoPro Plus side elements

Standard Sizes	
Styles	Overall frame dimension (ordering size)
Glass infill: 010, 015, 020, 025, 030, 040, 700, 750, 850, 900	400 x 2,100
Special sizes	
Styles	Overall frame dimension (ordering size)
Glass infill: 010, 015, 020, 025, 030, 040, 700, 750, 850, 900	ThermoPro: 300-1,000* x 1,875-2,250 ThermoPro Plus: 300-1,000* x 1,875-2,250
Panel infill: 100, 200, 400	450 x 1,990-2,186

ThermoPro / ThermoPro Plus transom lights

Special sizes	
Styles	Overall frame dimension (ordering size)
Glass infill: 010, 015, 020, 025, 030, 040, 700, 750, 900	875-2,250 x 300-500

* Transom light not possible from a width of 500 mm. Door sets with side elements does not contribute to the static equilibrium, which must be guaranteed by the building structure.

ThermoPro Plus

Frame variants

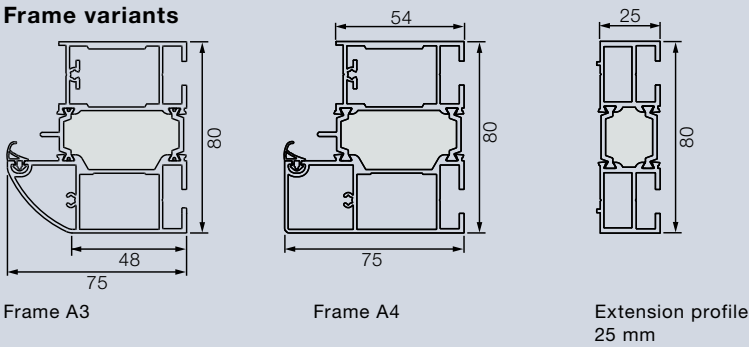

Horizontal view of door

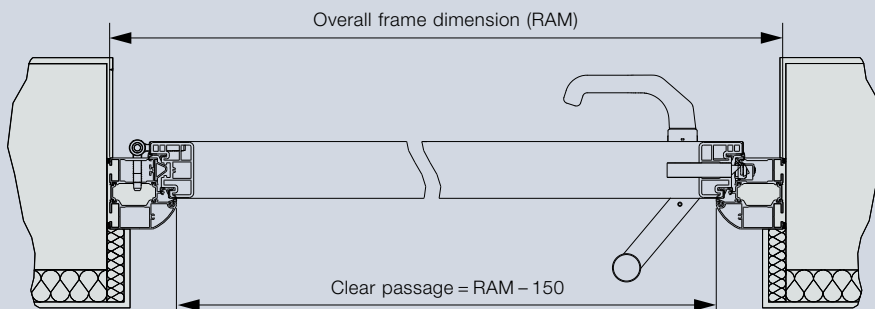

Vertical view of door

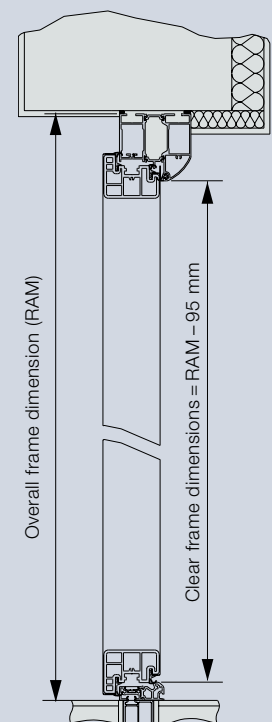

Horizontal view of side element

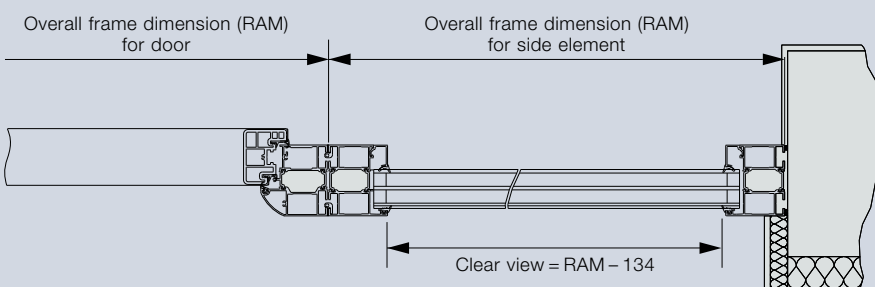



Experience Hörmann quality

For all applications in new buildings and modernisation projects

Hörmann provides an excellent basis for comprehensive planning. Carefully matched solutions offer you the very best in perfectly designed products for every area.

Garage doors

Optimally match your personal architectural style: up-and-over or sectional doors made of steel, timber or grp.

Door operators

Enjoy extra convenience and break-in resistant security: Hörmann operators for garage doors and entrance gates.

Entrance doors

Our comprehensive entrance door ranges include models that fit almost every need and requirement.

Steel doors

Sturdy doors for your whole home, from basement to roof.

Frames

Choose from our comprehensive range of products for new construction, expansion and modernisation.



Garage doors and operators



ThermoPro entrance doors



Steel doors

www.hormann.co.uk

Hörmann: Quality without Compromise



Hörmann KG Amshausen, Germany



Hörmann KG Antriebstechnik, Germany



Hörmann KG Brandis, Germany



Hörmann KG Brockhagen, Germany



Hörmann KG Dissen, Germany



Hörmann KG Eckelhausen, Germany



Hörmann KG Freisen, Germany



Hörmann KG Ichtshausen, Germany



Hörmann KG Werne, Germany



Hörmann Genk NV, Belgium



Hörmann Alkmaar B.V., Netherlands



Hörmann Legnica Sp. z o.o., Poland



Hörmann Beijing, China



Hörmann Tianjin, China



Hörmann LLC, Montgomery IL, USA



Hörmann Flexon LLC, Burgettstown PA, USA

Hörmann is the only manufacturer worldwide that offers you a complete range of all major building products from one source. We manufacture in highly-specialised factories using the latest production technologies. The close-meshed network of sales and service companies throughout Europe, and activities in the USA and China, make Hörmann your strong partner for first-class building products, offering "Quality without Compromise".

GARAGE DOORS
OPERATORS
INDUSTRIAL DOORS
LOADING EQUIPMENT
HINGED DOORS
DOOR FRAMES

Hörmann (UK) Ltd, Gee Road, Coalville, Leicestershire LE67 4JW
Phone (01530) 513000, Fax (01530) 513001

